

stryker®

WiSe™ HDTV Receiver

User Guide

REF 0240030972
WiSe™ HDTV Receiver

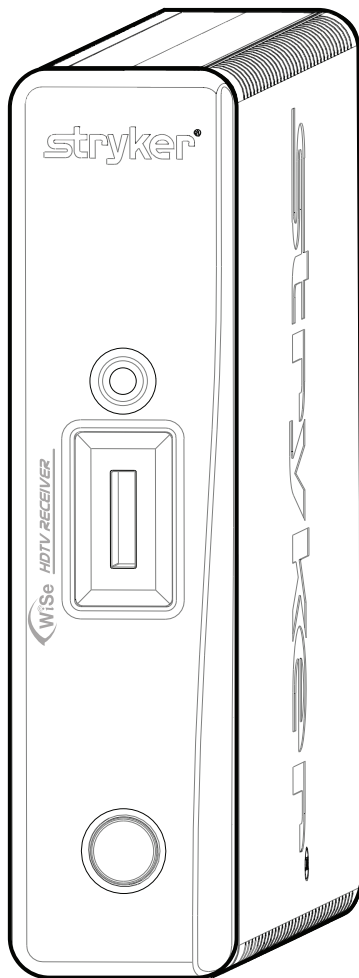

R_x ONLY

Table of Contents

- 1 Warnings and Cautions**
- 3 Symbols**
- 3 Product Description**
- 3 Intended Use**
- 4 Indications and Contraindications**
- 4 Package Content**
- 5 Device Features**
 - 5 Front Panel
 - 5 Rear Panel
- 6 Setup**
 - 6 Connecting AC Power
 - 6 Wall Mount Adapter Mounting Options
 - 7 Routing Video Configuration Setup #1
 - 9 Routing Video Configuration Setup #2
- 10 Instructions for Use**
 - 10 Link the Transmitter to the Receiver
- 11 Cleaning**
- 12 Troubleshooting**
- 13 Technical Specifications**
- 14 Electromagnetic Compatibility**

Warnings and Cautions

Please read this manual and follow its instructions carefully. The words warning, caution, and note carry special meanings and should be carefully reviewed:

Warning The personal safety of the patient may be involved. Disregarding this information could result in personal injury.



An exclamation mark within a triangle is intended to alert the user to the presence of important operating and maintenance instructions in the literature accompanying the device.

Caution Special service procedures or precautions must be followed to avoid damaging the device.



A lightning bolt within a triangle is intended to warn of the presence of hazardous voltage. Refer all service to authorized personnel.

Note Special information to make maintenance easier or important information more clear.

Warnings

To avoid potential serious injury to the user and the patient and/or damage to this device, please note the following warnings:

- Read the operating manual thoroughly and be familiar with its contents prior to using this device.
- Carefully unpack the device and check if any damage occurred during shipment.
- Test this device prior to a surgical procedure. This device was fully tested at the factory before shipment.
- Do not put any liquid into the device. If this occurs, unplug the device and have it checked by qualified personnel before operating it any further.
- Avoid disassembling any part of the WiSe HDTV Receiver or the WiSe R1-R2 adapter cover, as doing so may break the seals, causing leakage and/or electric shock.
- Avoid removing the WiSe HDTV Receiver or the WiSe R1-R2 adapter cover, as doing so may cause damage to electronics and/or electric shock.
- Ensure that the electrical installation of the relevant operating room complies with NEC and CEC guidelines.
- Do not attempt internal repairs or adjustments not specifically detailed in this operating manual. Ensure that readjustments, modifications, and/or repairs are carried out by persons authorized by Stryker Endoscopy.
- Use appropriate caution to prevent contact with fluids if the device is being used with a power supply in patient environments.
- Federal law (Devised States of America) restricts this device to sale by, or on the order of, a physician.
- Ensure the device is mounted securely. Damage to the device or personal injury can occur if the device is not installed as instructed.

Cautions

- Plug the AC adapter into a grounded power outlet.
- Use only the proprietary power supply. Completely secure the connection between the DC power cord and the extension cord.
- To connect to an international power supply, use an attachment plug appropriate for the power outlet.
- Power off the device when it is not in use.
- Remove the power module and connection when transporting the device.
- Unplug the device if it is not to be used for an extended period of time.
- Never operate the device immediately after transportation from a cold location to a warm location.
- Pay close attention to the care and cleaning instructions in this manual. A deviation may cause damage.
- Do not expose the WiSe HDTV Receiver console to moisture. Spray the cleaning solution into a soft cloth and clean gently.
- Do not sterilize the WiSe HDTV Receiver console, as the delicate electronics cannot withstand this procedure.
- Allow adequate air circulation to prevent internal heat buildup. Do not place the device on surfaces (rugs, blankets, etc.) or near materials (curtains, draperies) that may block the ventilation slots. The WiSe HDTV Receiver console is cooled by natural convection and has no fan.
- Do not install the device near sunlight or excessive dust.
- Do not touch the patient with signal input or output connectors. Equipment with SIP/SOP connectors should either comply with IEC 60601-1 and/or IEC 60601-1-1 harmonized national standards or the combination should be evaluated for safety.
- To ensure electromagnetic compatibility, refer to the “Electromagnetic Compatibility” section of this manual. The WiSe HDTV Receiver (REF#0240030972) must be installed and operated according to the EMC information provided in this manual.
- The WiSe HDTV Receiver (REF#0240030972) has been tested under the UL 60601-1 standard and is UL listed for medical application. The warranty is void if any of these warnings or cautions are



















disregarded.

- Changes or modifications not expressly approved by the party responsible for compliance could void the user’s authority to operate the device.

Note: *This device has been tested and found to comply with the limit for a Class B digital device, pursuant to Part 15 of the FCC Rules. These limits are designed to provide reasonable protection against harmful interference in a residential installation. This device generates, uses, and can radiate radio frequency energy and, if not installed and used in accordance with the instructions, may cause harmful interference to radio communications. There is no guarantee that interference will not occur in a particular installation, which can be determined by turning the device off and on. The user is encouraged to try to correct the interference by one of the methods listed in the Troubleshooting section under the listed possible cause, “Interference.”*

Symbols

The following symbols appear on the device, its labeling, or the device packaging. Each symbol carries a special definition, as defined below:

	Direct Current		Degrees of protection against the ingress of water
	Wireless Transmission		For physician use only
	Tested to comply with FCC Class B standards		Protection against electrical shock - Class II
	Denotes compliance to CAN/CSA C22.2 No 601.1-M90 UL60601-1		Read Instructions for Use
	Operating Humidity Ratings		European Authorized Representative
	Operating Temperature Ratings		Serial Number
	For indoor use only		Reference Number
	Fragile		Manufacturer
	This symbol indicates that the waste of electrical and electronic equipment must not be disposed as unsorted municipal waste and must be collected separately. Please contact the manufacturer or other authorized disposal company to decommission your device.		Made in the USA

Product Description

The WiSe HDTV Receiver (Receiver) is an extension of the WiSe HDTV System and uses a radio frequency (RF) link to receive high definition video and remote signals from the WiSe HDTV Transmitter (Transmitter). The Receiver has one DVI and two remote outputs which allow it to be used with the Stryker Digital Capture (SDC) device and Stryker surgical viewing displays with DVI input. It uses the same wireless technology as in the WiSe HDTV System. The Receiver has a bi-color LED for device status, the same token and token slot as the current WiSe HDTV system, compact wireless router style design with multiple placement options, and simple mode of operation. The R1-R2 adapter (Optional Accessory) will be used on the Transmitter side to accept R1 and R2 cable connections.

Intended Use

The WISE HDTV Receiver, when connected with the compatible Stryker monitors/DVI devices, is intended for wireless video display during surgical procedures including arthroscopy orthopedic surgery, laparoscopy (general and gynecological surgery), thorascopy, endoscopy (general, gastroenterological and ENT surgery), and general surgery.

The WISE HDTV Receiver, when connected with the SDC, is intended for wireless transfer of image data including video and remote signal between medical devices (optional).

The WISE HDTV Receiver is a non-sterile reusable accessory not intended for use in the sterile field. The WISE HDTV Receiver is intended for use by qualified physicians having complete knowledge of these surgical procedures.

Indications and Contraindications

The WiSe HDTV Receiver, when connected with the Stryker display(s), as an accessory to the surgical camera, is intended for visualization during surgical procedures including:

- General surgery
- General laparoscopy
- Nasopharyngoscopy
- Ear endoscopy
- Sinuscopy
- Plastic surgery wherever a laparoscope/endsocope/arthroscope is indicated for use
- Other endoscopic surgeries including:

Laparoscopic cholecystectomy, laparoscopic hernia repair, laparoscopic appendectomy, laparoscopic pelvic anterior spinal fusion, anterior cruciate ligament reconstruction, knee arthroscopy, shoulder arthroscopy, small joint arthroscopy, decompression fixation, wedge resection, flexible endoscopy, urology, gynecology, lung biopsy, pleural biopsy, dorsal sympathectomy, pleurodesis, internal mammary artery dissection for coronary artery bypass, coronary artery bypass grafting where endoscopic visualization is indicated and examination of the evacuated cardiac chamber during performance of valve replacement.

There are no known contraindications.

Package Content



REF# 0240030972

(1) WiSe HDTV Receiver

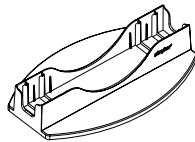

REF# P11883

(1) Base Stand

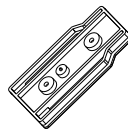

REF# P11281

(1) Wall Mount Adapter

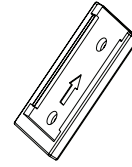

REF# P11139

(1) Wall Mount Plate

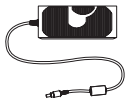

REF# P11142

(1) AC Adapter

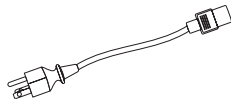

REF# 0105033001

(1) Hospital-grade
AC power cord

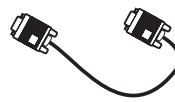

REF# 0105207131

(1) DVI Cable, 3FT

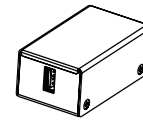

REF# P12866

(1) R1-R2 Adapter
(Optional Accessory)



REF# P13014

(1) USB A to B Cable
(Optional Accessory)



REF# 0105207102

(2) 6-32 x 5/16" Philips
Pan Split/Flat Washer
Sems

Device Features

The Receiver can be used with the Transmitter (REF#0240030971), which allows it to receive a high-definition video and remote signals over a radio-frequency link. This link is established by means of the token (REF#0240030974), which is included with the Transmitter.

Front Panel

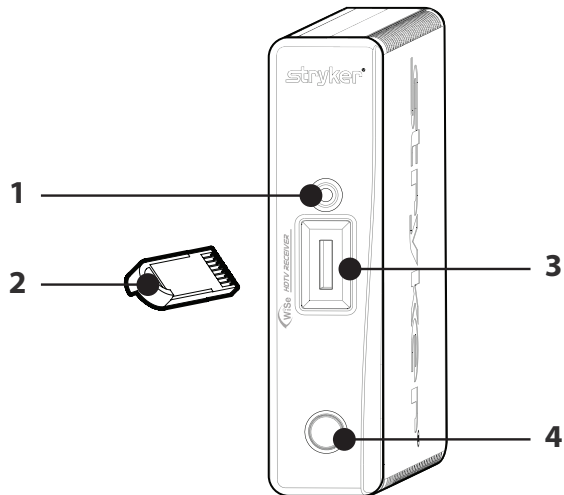

- | | |
|---|---|
| 1. Token Status LED | Provides feedback when linking the Receiver and the Transmitter |
| 2. Token (Included with the Transmitter) | Initializes the wireless connection after insertion into the Transmitter and the Receiver and display |
| 3. Token Slot | Site of insertion for the token to establish a wireless connection |
| 4. Power switch | Powers the Receiver ON and OFF |

Rear Panel

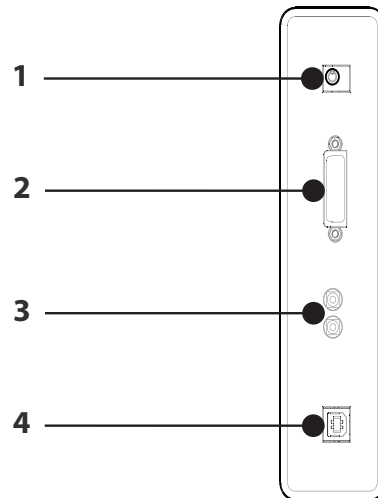

- | | |
|---------------------------|--|
| 1. DC Power Inlet | 5 VDC input; connects to separable hospital-grade AC power cord that can be used for mains isolation |
| 2. DVI Output | Connects to SDC or any other display |
| 3. Remotes 1 and 2 | Connects to SDC |
| 4. RS232 Port | Maintenance port (not for customer use) |

Setup



Warning

When the Receiver is used with other devices, leakage currents may be additive. Ensure that all systems are installed according to the requirements of IEC 60601-1-1.

Always set up the Receiver in a location that allows adequate ventilation. Insufficient ventilation may cause the Receiver to overheat and shut down.

Connecting AC Power



Warning

Always use the hospital-grade AC power cord supplied with the Receiver.

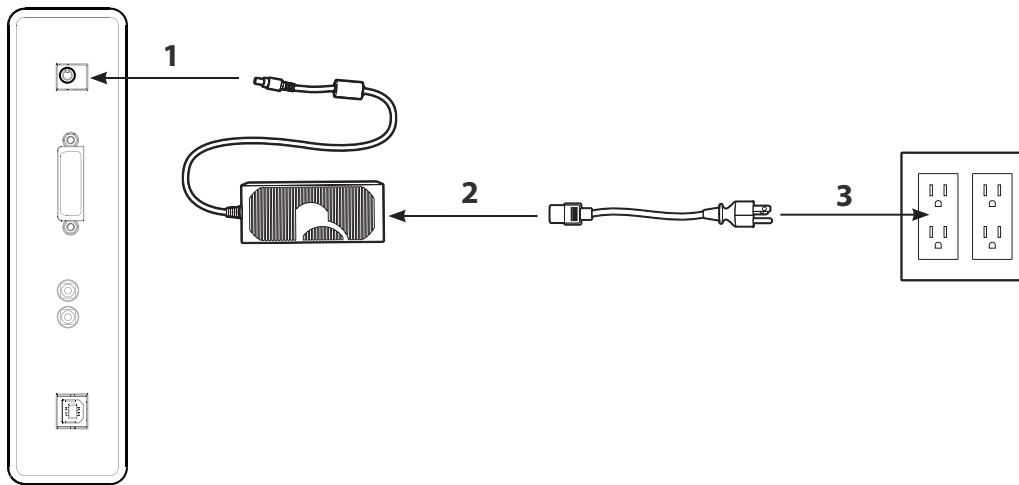

1. Connect the AC adapter to the 5V input on the Receiver.
2. Connect the power cord to the power supply.
3. Connect to the AC mains using the supplied hospital-grade AC power cord.

Wall Mount Adapter Mounting Options

1. Line up dimple and thru holes.

Orient the Wall Mount Adapter in such a way that the dimple and thru holes line up with the blind hole and threaded PEMS on the Receiver.

2. Secure the Wall Mount Adapter onto the Receiver console.

Use two 6-32 x 5/16" Phillips Pan Split/Flat Washer SEMS (REF#0105207102) using a Phillips screw driver.

Routing Video Configuration Setup #1

Please refer to diagram on the opposite page.

Notes:

- *The devices listed in the diagram are examples only. The setup is applicable to compatible devices.*
- *Connect a video cable (DVI, VGA, S-Video) from the camera control device to a display to provide a wired backup signal.*
- *Place the Receiver at least 4 feet (120 cm) away from the front panel of Transmitter #2.*
- *Ensure that the Receiver is not placed within Transmitter #2's front field of vision.*

1. Connect a DVI cable from DVI Output 1 on the camera control device to the DVI Input on the Transmitter #1.
2. Connect the remote cables from the camera control device to the R1-R2 Adapter (Optional).
3. Connect a USB cable from the R1-R2 adapter to the Transmitter #1 (Optional).
4. Connect a DVI cable from the Receiver to the SDC DVI Input.
5. Connect the remote cables from the Receiver to the SDC.
6. Connect a DVI cable from the SDC Output to the DVI Input on the Transmitter #2.
7. Link the Transmitter #1 to the Receiver as shown.
8. Link the Transmitter #2 to up to 3 displays as shown (or up to 3 Receivers, or a combination of 3 Receivers and displays).

Setup Example #1



Cart/Boom

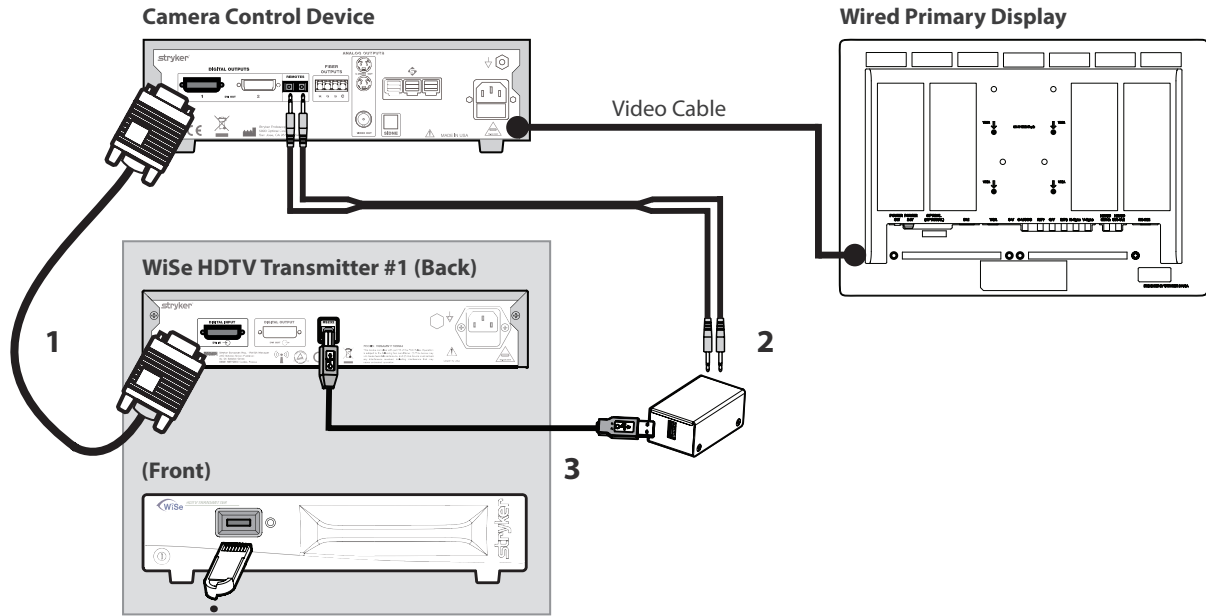

Doc Station

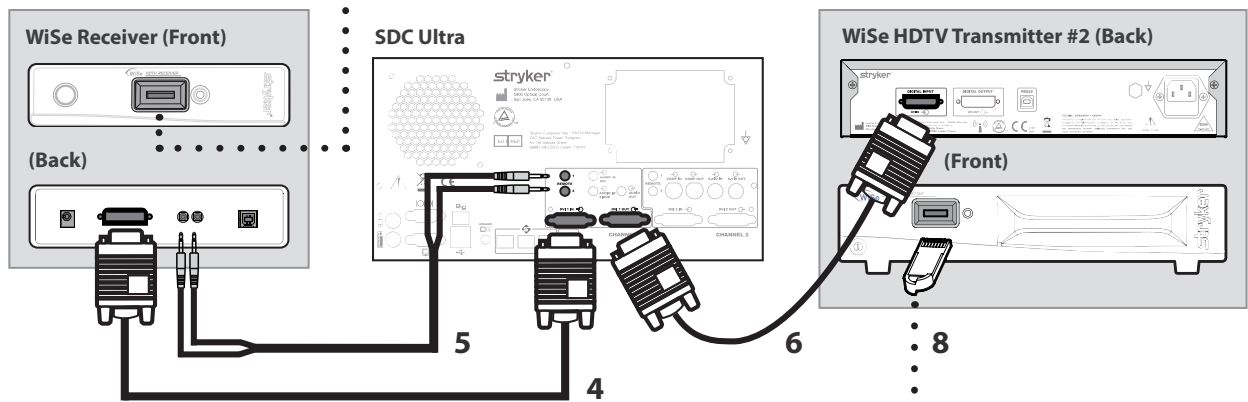

Operating Room

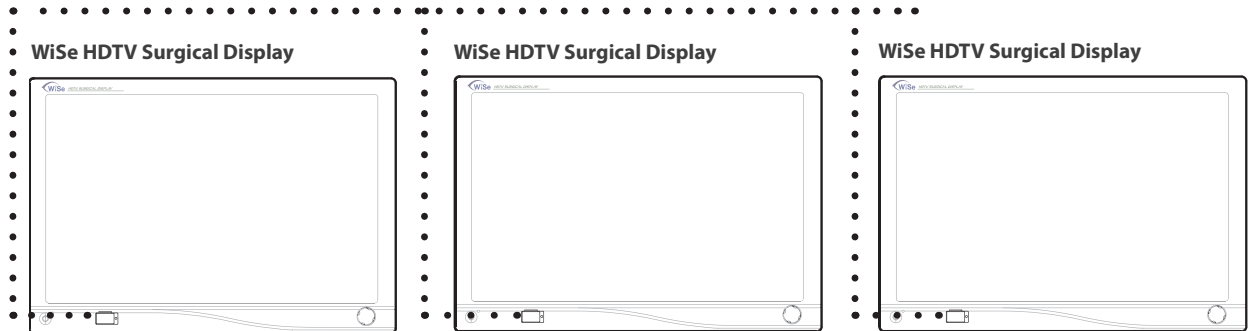

Routing Video Configuration Setup #2

- Connect a DVI cable from the DVI Output on the:
 1. Camera control device to the DVI Input on the SDC.
 2. SDC to the DVI Input on the Transmitter.
 3. Transmitter to the primary surgical display.
 4. DVI Output on the Receiver to the auxiliary surgical display or DVI compatible device.
- Link the Transmitter to the Receiver as shown.

Setup Example #2

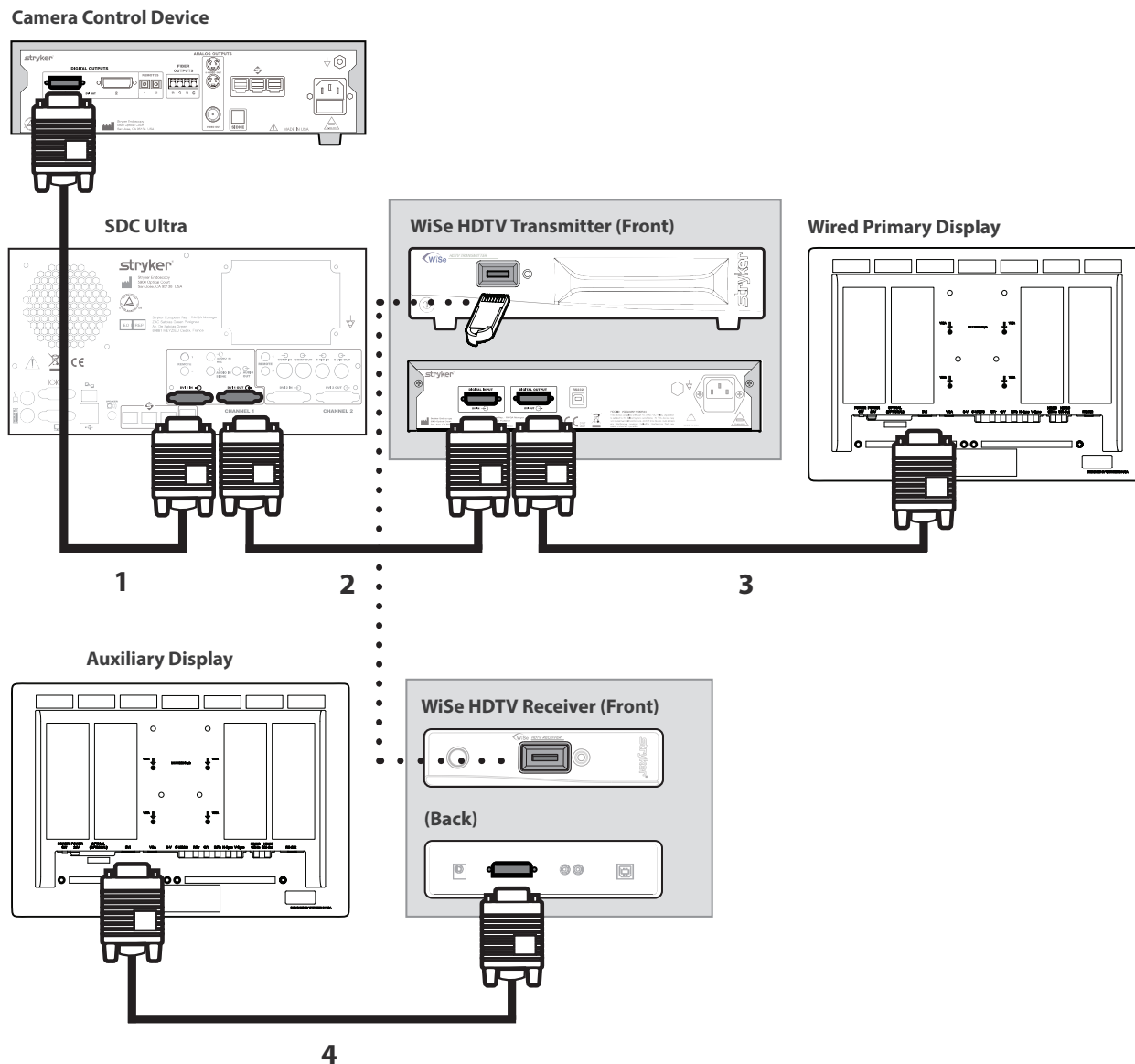

Instructions for Use

Link the Transmitter to the Receiver

Cautions Devices that employ RF communications may affect the normal function of the Receiver. When choosing a location for the Receiver, consult the “Electromagnetic Compatibility” section of this manual to ensure proper function.

In accordance with patient privacy laws, do not transmit personal patient information, such as EKG, EEG, patient name, or patient ID over the wireless signal.

Notes

- The following graphic will display for 5 minutes after the Receiver is turned on, or after the connection is lost, or until linking begins. This indicates that no connection has been established between a Transmitter and the Receiver.
- The Receiver functions on a wireless 20 MHz channel in the 4.9 – 5.9 GHz spectrum. As necessary, remove other wireless devices in the same frequency band from the environment to make channels available for the Transmitter and the Receiver.
- To link the Receiver to the Transmitter, and thereby enable wireless communication, any blue Transmitter token will suffice.
- If multiple Transmitters are within 100 feet of each other, for example, in adjacent operating rooms, link each Transmitter to its respective Receiver one set at a time. Wait 15 seconds before linking the next Transmitter/Receiver set.

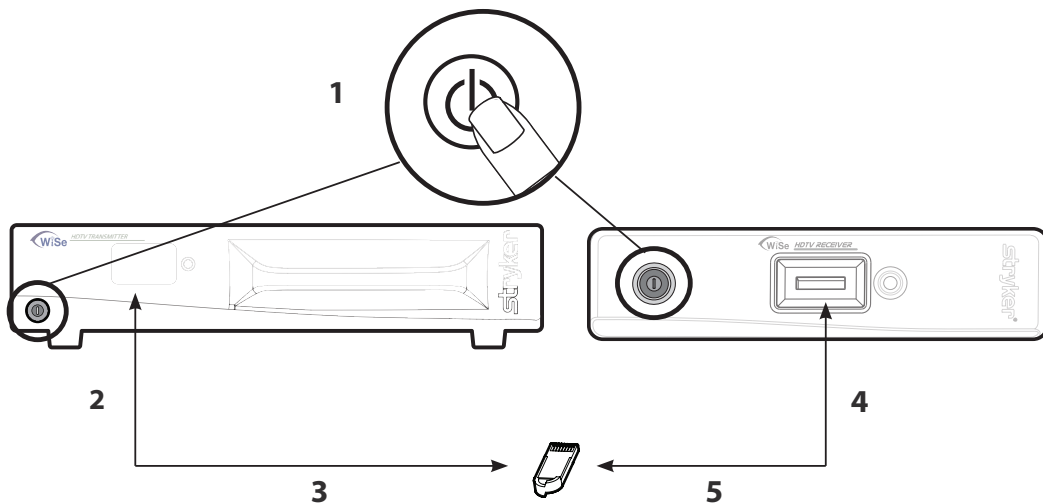

1. Power on the Transmitter and the Receiver. The token LED shines amber as the devices perform startup functions and then turns off when there is no token inserted the token slot.
2. Insert the token into the Transmitter's token slot. The token LED also shines amber as it writes the data.
3. When the token LED turns green, remove the token from the Transmitter.
4. Within 2 minutes, insert the token into the token slot on the Receiver. An audible tone will sound from the Transmitter, and the token LED will change from amber to green when the Receiver and the Transmitter have been linked.
5. Remove the token from the token slot on the Receiver.

Cleaning



Warning

Unplug the device from the electrical outlet before cleaning.

Cautions

- Do not sterilize the device.
- Never submerge the Receiver or allow liquids to enter the Receiver. Wipe any cleaning agents off the Receiver immediately using a water dampened cloth.
- The surface finish will be permanently damaged by strong chemicals and solvents such as acetone and trichloroethylene. Damage caused by the use of unapproved substances or processes will not be covered by warranty.
- It is recommend to test any cleaning solution on a small area of the Receiver that is not visible to verify compatibility.
- Do not use steel wool or other abrasive material to clean the Receiver.

1. The Receiver may be cleaned with either Steris Coverage Spray HB Plus or ASP Enzol Enzymatic Detergent Solution.
2. Spray the cleaning agent on a soft cloth and wipe down the Receiver.
3. Using a dry, soft cloth, dry the Receiver thoroughly.

Troubleshooting

Before returning the Receiver for service, consult the troubleshooting list below:

Problem	Possible Cause	Possible Solution
No picture	No Power	Ensure the power switch at the front and back of the display are set to ON.
		Check if the AC power cord is properly connected to the AC adapter and outlet.
	No Video	Check if the video signal cable is properly connected at the back of the Receiver.
		Check if the power of the video signal source system is ON.
No picture and LED stays amber for longer than 10 seconds	Bad or unprogrammed token inserted	Re-insert the token into the Transmitter. Repeat steps 2 through 4 of the “Linking the Transmitter to Receiver” instructions section on the affected Receiver only.
LED stays amber for longer than 10 seconds	Bad or unprogrammed token inserted	Re-insert the token into the Transmitter. Repeat steps 2 through 4 of the “Linking the Transmitter to Receiver” instructions section on the affected Receiver only.
	System is busy	Wait for 10 seconds.
	System error has occurred	Restart the Receiver. Repeat steps steps 2 through 4 of the “Linking the Transmitter to Receiver” instructions section on the affected Receiver only.
Wireless link not established within 2 minutes (with optional Transmitter).	“Digital RGB No Signal” on screen image	Cycle the power by cycling the hard power switch at the front of the Transmitter. Repeat steps 2 through 4 of the “Linking the Transmitter to Receiver” instructions section on the affected Receiver only.
	“No Link” on screen image	
Wireless link established with some but not all Receivers (with Transmitter).	“Digital RGB No Signal” on screen image	Cycle the power on the affected Receiver. Repeat steps 2 through 4 of the “Linking the Transmitter to Receiver” instructions section on the affected Receiver only.
Poor video quality or trouble establishing/maintaining a wireless link	Interference	Reorient or relocate the Receiver.
		Connect the device to an outlet on a circuit different from that to which the other device(s) are connected.
		Consult the manufacturer or sales representative for help.

Technical Specifications

Video Output

Digital Connector: One Digital Video Interface (DVI), 29-pin DVI-I

Remote Output Connector: 2.5mm phone jack

Video Formats

1920 × 1080 @ 60 Hz/50Hz

1280 × 1024 @ 60Hz/50 Hz

1280 × 720 @ 60 Hz/50Hz

1024 x 768 @ 60 Hz

Operating Conditions

Temperature: 41 – 104°F (5 – 40°C)

Relative Humidity: 30 - 95%

Transport and Storage Conditions

Temperature: -0.4 – 140°F (-18 – 60°C)

Relative Humidity: 15 - 90%

Electrical

AC Adapter Model: MW172KB0503F01

Input: 100-240 VAC, 50-60 Hz, 0.5 A

Output: +5VDC, 3.0 A

Total Shipping Weight

6.8 lb

Dimensions

Receiver Console: 1.750" W x 9.388" L x 7.000" H

(4.4 cm w x 23.8 cm l x 17.7 cm h)

Wireless

Frequency: 4.9 – 5.9 GHz

Channel Bandwidth: 20 MHz

Channel Allocation: Automatic frequency selection with prescan

Protocol: Orthogonal Frequency Division

Multiplexing (OFDM) with Multiple Input Multiple Output (MIMO)

Classification

Class II Equipment

Water Ingress Protection, IPX0 — Ordinary Equipment

Continuous Operation

Compliance

Medical Safety Standards

IEC 60601-1:1988 + A1:1991 + A2:1995

CAN/CSA C22.2 NO.601.1-M90:2003

UL 60601-1:2003

AS/NZS 3200.1.0:1998

CSA 22.2.601.1.1:2002

Medical EMC Standard

IEC 60601-1-2:2007

ETSI EN 301 489 V1.8.1

IC Regulations

IC:7680A-AMN11100 (WiSe HDTV Transmitter)

IC:7680A-AMN12100 (WiSe HDTV Display,

WiSe HDTV Receiver)

FCC Regulations

FCC 15B 2008 (Class B)

FCC Identifier: VQSAMN12100R44

Please contact your local Stryker Endoscopy sales representative for information on changes and new products.

Electromagnetic Compatibility



When this device is connected with other electrical equipment, leakage currents may be additive. To minimize total leakage current per patient, ensure that all systems are installed according to the requirements of IEC 60601-1-1.

Caution Portable and mobile RF communications equipment may affect the normal function of the Receiver.

Do not use cables or accessories other than those provided with the Receiver, as this may result in increased electromagnetic emissions or decreased immunity to such emissions.

If the display is used adjacent to or stacked with other devices, observe and verify normal operation of the display and transmitter in the configuration in which it will be used prior to using it in a surgical procedure. Consult the tables below for guidance in placing the Receiver and Transmitter.

Like other electrical medical equipment, the Receiver requires special precautions to ensure electromagnetic compatibility with other electrical medical devices. To ensure electromagnetic compatibility (EMC), the Receiver must be installed and operated according to the EMC information provided in this manual. The Receiver has been designed and tested to comply with IEC 60601-1-2:2001 requirements for EMC with other devices. The WiSe HDTV Receiver is intended for use in the electromagnetic environment specified below. The customer or the user of the WiSe HDTV Receiver should ensure it is used in such an environment.

Guidance and Manufacturer's Declaration: Electromagnetic Emissions

Emissions Test	Compliance	Electromagnetic Environment - guidance
RF emissions CISPR 11	Group 1	The WiSe HDTV Receiver uses RF energy only for its internal function; therefore, its RF emissions are very low and are not likely to cause any interference in nearby electronic equipment.
RF emissions CISPR 11	Class B	The WiSe HDTV Receiver is suitable for use in all establishments other than domestic establishments and those directly connected to the public low-voltage power supply network that supplies buildings used for domestic purposes, provided the following warning is heeded: Warning: This system is intended for use by health care professionals only. This system may cause radio interference or may disrupt the operation of nearby equipment. It may be necessary to take mitigation measures, such as reorienting or relocating the system or shielding the location.
Harmonic emissions IEC61000-3-2	Class A	
Voltage Fluctuations/ flicker emissions IEC61000-3-3	Complies	

Guidance and Manufacturer's Declaration: Electromagnetic Immunity

Immunity Test	IEC 60601 Test Level	Compliance Level	Electromagnetic Environment Guidance
Electrostatic Discharge (ESD) IEC61000-4-2	6kV contact 8kV air	6kV contact 8kV air	Floors should be wood, concrete, or ceramic tile. If floors are covered with synthetic material, the relative humidity should be at least 30%.
Electrical fast transient/burst IEC61000-4-4	2kV for power supply lines 1kV for input/output lines	2kV line to ground 1kV line to line	Mains power quality should be that of a typical commercial or hospital environment.
Surge IEC61000-4-5	1kV differential mode 2kV common mode	1kV differential mode 2kV common mode	Mains power quality should be that of a typical commercial or hospital environment
Voltage dips, short interruptions and voltage variations on power supply input lines IEC61000-4-11	<5% Ut (>95% dip in Ut) for 0.5 cycle 40% Ut (60% dip in Ut) for 5 cycles 70% Ut (30% dip in Ut) for 25 cycles <5% Ut (>95% dip in Ut) for 5 sec.	<5% Ut (>95% dip in Ut) for 0.5 cycle 40% Ut (60% dip in Ut) for 5 cycles 70% Ut (30% dip in Ut) for 25 cycles <5% Ut (>95% dip in Ut) for 5 sec	Mains power quality should be that of a typical commercial or hospital environment. If the user of the transmitter requires continued operation during power mains interruptions, it is recommended that the WiSe HDTV Receiver be powered from an uninterruptible power supply or a battery.
Power frequency (50/60Hz) magnetic field IEC 61000-4-8	3.0 A/m	3.0 A/m	Power-frequency magnetic fields should be at levels characteristic of a typical location in a typical commercial or hospital environment.

Note: Ut is the AC mains voltage prior to application of the test level.

Guidance and Manufacturer's Declaration: Electromagnetic Immunity

Portable and mobile RF communications equipment should be used no closer to any part of the WiSe HDTV Receiver, including its cables, than the recommended separation distance calculated from the equation applicable to the frequency of the transmitter.

Immunity Test	IEC 60601 Test level	Compliance Level	Electromagnetic Environment Guidance
Conducted RF IEC 61000-4-6	0.15 - 80 MHz 3 Vrms 1 kHz	0.15 - 80 MHz 3 Vrms 1 kHz	Recommended Separation Distance $d = 1.17\sqrt{P}$
Radiated RF IEC 61000-4-3	80 MHz - 2.5 GHz 3 V/m 80% @ 1 kHz	80 MHz - 2.5 GHz 3 V/m 80% @ 1 kHz	$d = 1.17\sqrt{P}$ 80 MHz to 800 MHz $d = 2.33\sqrt{P}$ 800 MHz to 2.5 GHz where P is the maximum output power rating of the transmitter in watts (W) according to the transmitter manufacturer and d is the recommended separation distance in meters (m). Field strengths from fixed RF transmitters, as determined by an electromagnetic site survey (a), should be less than the compliance level in each frequency range (b).  Interference may occur in the vicinity of equipment marked with the following symbol

Notes:

- At 80 MHz and 800 MHz, the higher frequency range applies.
 - These guidelines may not apply in all situations. Electromagnetic propagation is affected by absorption and reflection from structures, objects, and people.
- (a) Field strengths from fixed transmitters, such as base stations for radio (cellular/cordless) telephones and land mobile radios, amateur radio, AM and FM radio broadcast, and TV broadcast, cannot be predicted theoretically with accuracy. To assess the electromagnetic environment due to fixed RF transmitters, an electromagnetic site survey should be considered. If the measured field strength in the location in which the WiSe HDTV Receiver is used exceeds the applicable RF compliance level above, the display and transmitter should be observed to verify normal operation. If abnormal performance is observed, additional measures may be necessary, such as reorienting or relocating the WiSe HDTV Receiver.
- (b) Over the frequency range 150 kHz to 80 MHz, field strengths should be less than 3 V/m.

Recommended Separation Distances Between Portable and Mobile RF Communications Equipment and the WiSe 26" HDTV Receiver

The WiSe HDTV Receiver is intended for use in an electromagnetic environment in which radiated RF disturbances are controlled. The user of the WiSe HDTV Receiver can help prevent electromagnetic interference by maintaining a minimum distance between portable and mobile RF communications equipment (transmitters) and the WiSe HDTV Receiver as recommended below, according to the maximum output power of the communications equipment.

Rated maximum output power (W) of transmitter	Separation distance (m) according to frequency of transmitter		
	150 kHz to 80 MHz $d = 1.17\sqrt{P}$	80 kHz to 800 MHz $d = 1.17\sqrt{P}$	800 kHz to 2.5 GHz $d = 1.17\sqrt{P}$
0.01	0.12	0.12	0.23
0.1	0.37	0.37	0.74
1	1.17	1.17	2.33
10	3.70	3.70	7.37
100	11.70	11.70	23.30

For transmitters rated at a maximum output power not listed above, the recommended separation distance (d) in meters (m) can be estimated using the equation applicable to the frequency of the transmitter, where P is the maximum output power rating of the transmitter in watts (W) according to the transmitter manufacturer.

Notes:

- At 80 MHz and 800 MHz, the separation distance for the higher frequency range applies.
- These guidelines may not apply in all situations. Electromagnetic propagation is affected by absorption and reflection from structures, objects, and people.



Stryker Endoscopy
5900 Optical Court
San Jose, CA 95138 USA
1-800-624-4422

U.S. Patents: www.stryker.com/patents

Wise™ is a trademark of Stryker Corporation.
Products referenced with ™ designation are trademarks of Stryker.
Products referenced with ® designation are registered trademarks of Stryker.
Produced for Stryker Endoscopy.



P13627E
2016/02