

CHANGE DIMENSIONS AS NEEDED FOR CUSTOM TOWERS

REV. NO.		REVISIONS	DATE	APPROVED
ZONE	REV.	DESCRIPTION		

Precision Sheet Metal
 Design ♦ Engineering ♦ Fabrication
 www.acumetalfab.com

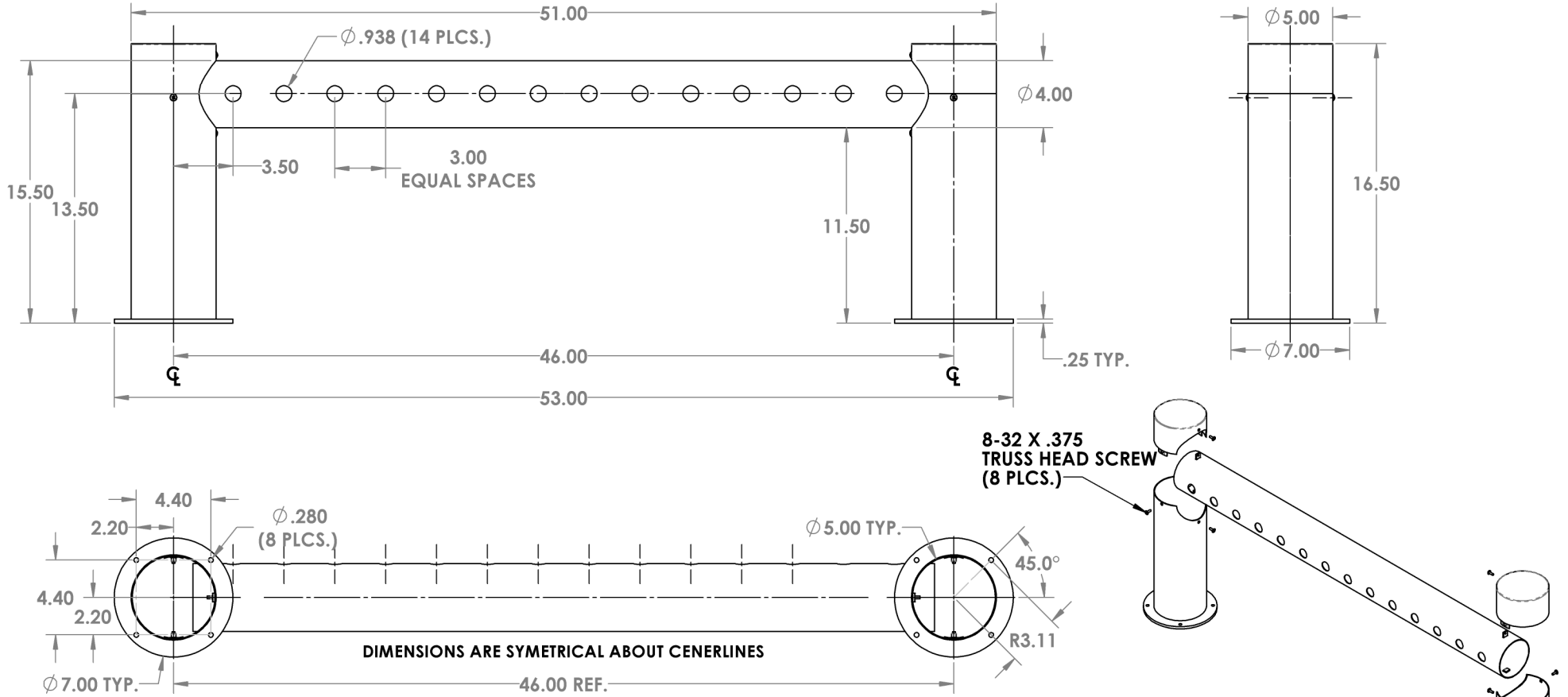

NOTES:

ALL DIMENSIONS ARE OUTSIDE DIMENSIONS (UNLESS OTHERWISE NOTED)

MATERIAL:

- Ø 4.00 X .06 WALL 304 STAINLESS STEEL TUBE
- Ø 5.00 X .06 WALL 304 STAINLESS STEEL TUBE

2 EA.	BASE TUBE	81026-01
2 EA.	TOP TUBE	81026-02
1 EA.	CROSS TUBE	81026-06

PART # 81026-PT51

PROPRIETARY AND CONFIDENTIAL
 THE INFORMATION CONTAINED IN THIS DRAWING IS THE SOLE PROPERTY OF ACU PRECISION SHEET METAL. ANY REPRODUCTION IN PART OR AS A WHOLE WITHOUT THE WRITTEN PERMISSION OF ACU PRECISION SHEET METAL IS PROHIBITED.
 ACU PRECISION SHEET METAL IS:
 AMERICAN COFFEE URN MANUFACTURING CO., INC

	NAME	DATE
DRAWN	L. WILLIAMS	03/18
MATERIAL	SEE NOTES	
FINISH	#8 POLISHED	

TITLE:
4 X 5 METRO PASS THROUGH TOWER 14 HOLE, 51" PASS THROUGH
AMERICAN COFFEE URN