

Artemide®

Cadmo

design by
Karim Rashid

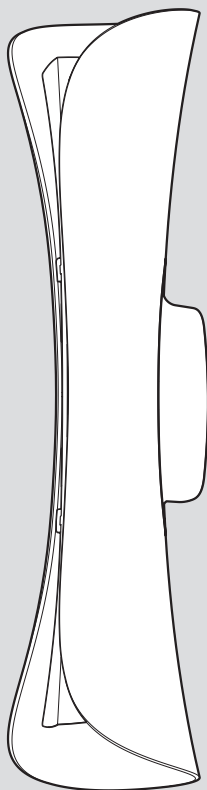



i

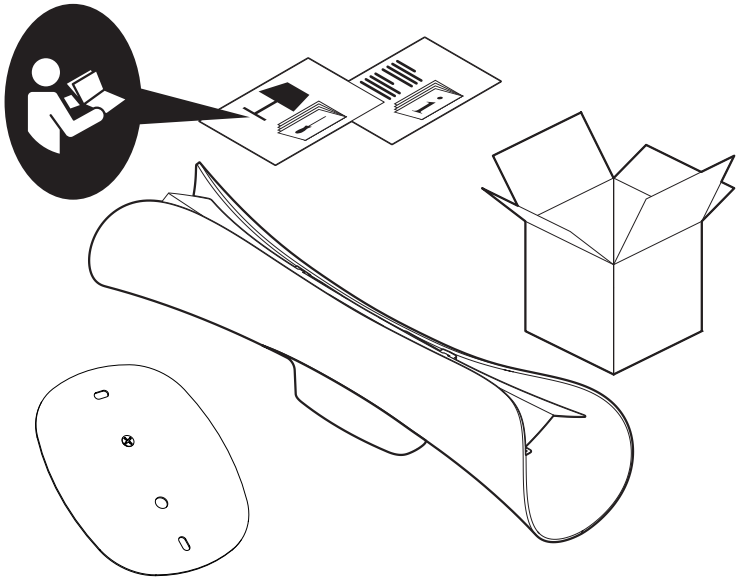

1

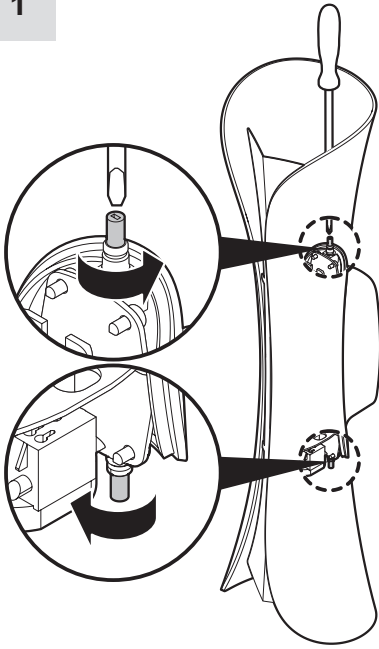

2

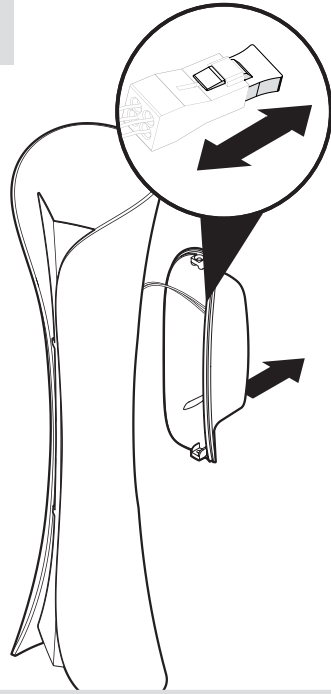

3

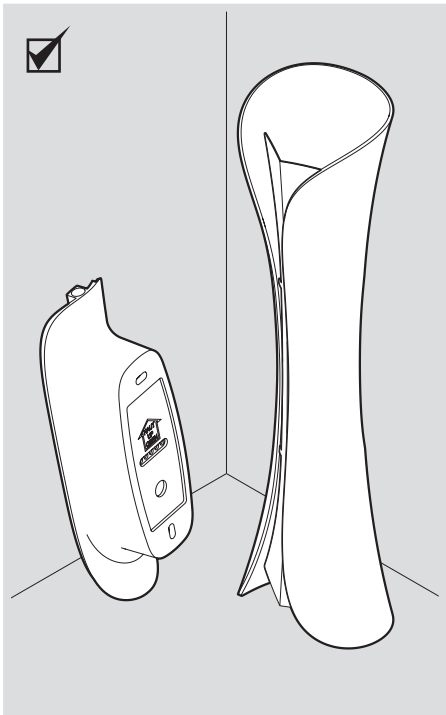
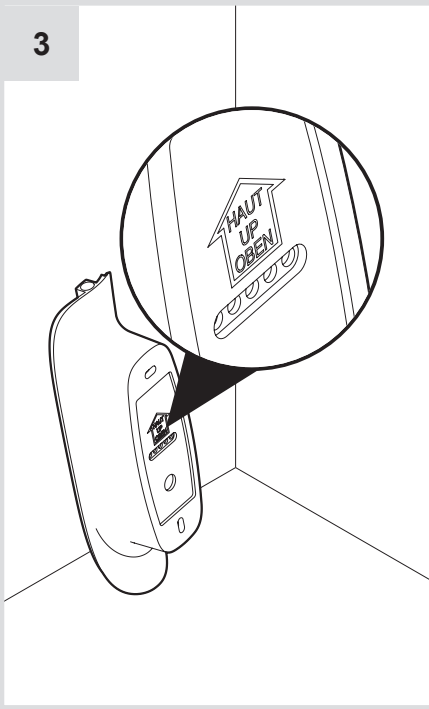

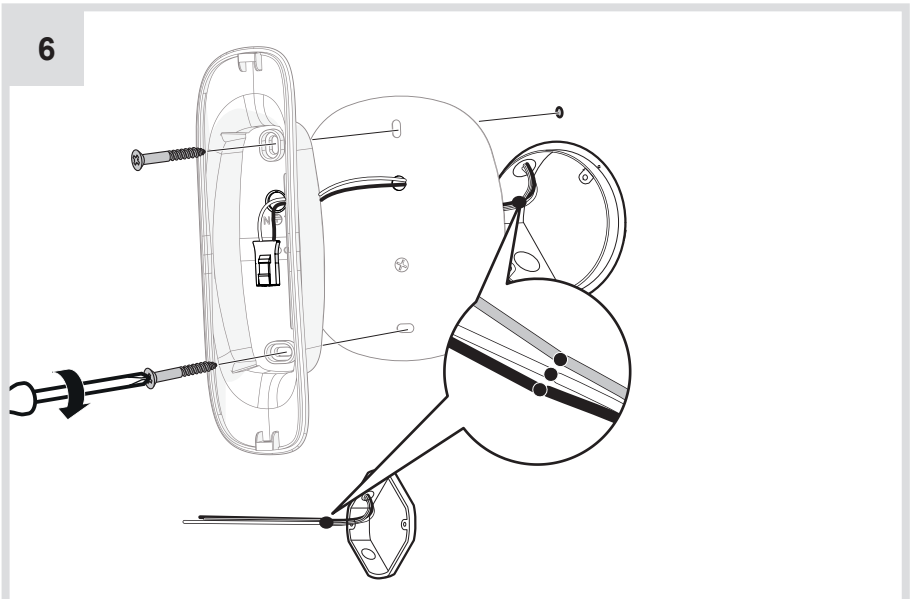
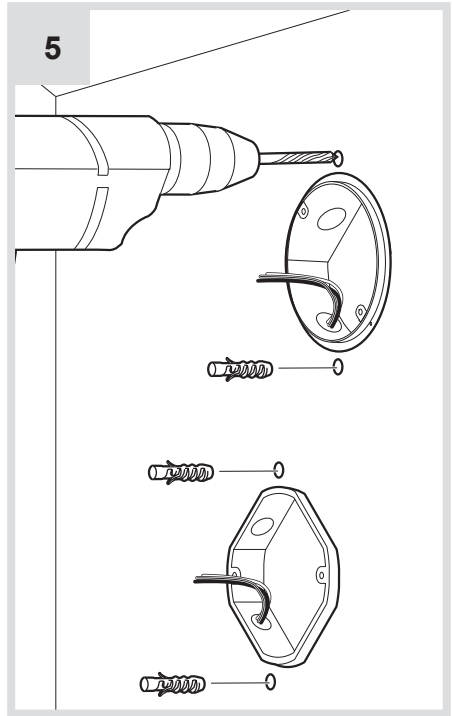
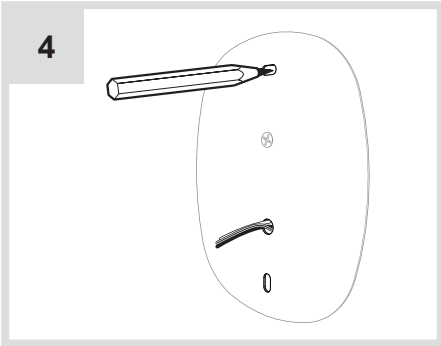
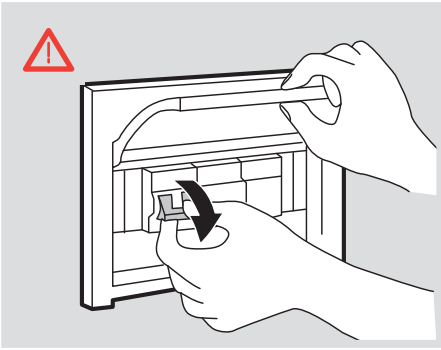

- | | | |
|--------------------|--|--------------------|
| white/blanc/blanco | | white/blanc/blanco |
| green/vert/verde | | green/vert/verde |
| black/noir/negro | | black/noir/negro |

9

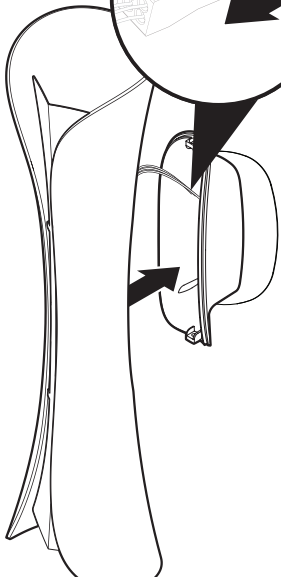
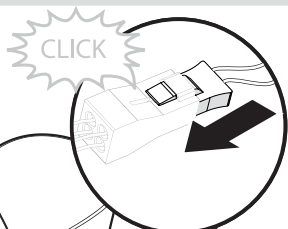

10

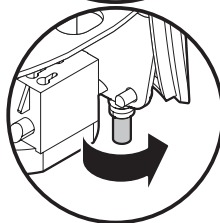
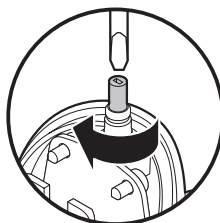



**2x MAX 10W
GU10 cULus
SBLED LAMP**

1

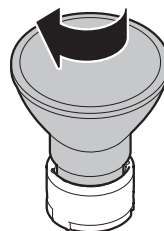
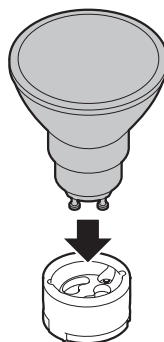

i



1

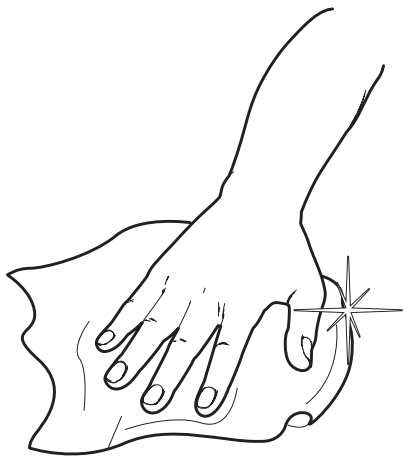

Artemide®



Artemide

via Bergamo, 18
20010 Pregnana M.se (MI)
ITALIA

tel. +39 02 935 181
fax +39 02 935 90 254
fax +39 02 935 90 496

www.artemide.com

VAT IT00846890150

Artemide Inc.

1980 New Highway
Farmingdale NY 11735

Tel. 631 694 9292
Toll Free 1-877-Art-9111
Fax 631 694 9275

www.artemide.us

Artemide Ltée/Ltd.

11105 rue Renaude Lapointe
Montréal, Québec H1J 2T4

Tel. 514 323 6537
Toll Free 888 777 2783
Fax 514 323 8864

www.artemide.ca

cod. Y513000219A